

WCON[®]
Connector & Cable Assembly **Stock Code:301328**

High end precision connectors and customer solution Service Provider

WWW.WCON.COM

WCON ELECTRONICS



Wcon, founded in Nov. 2002, is committed to provide a high end precision connectors and customer solution. The application industry of product ranges from industrial automation and control, battery, motor and electric control system of new energy vehicles and photovoltaic inverter system.

IATF16949
ISO9001
ISO14001
D-U-N-S[®]

UL/CUL
ROHS
REACH

- National High-Tech Enterprise
- China Well-known Trademark Enterprise
- AAA level Enterprise of Observing Contract and Valuing Credit
- Professional, Proficient, Special, New Enterprise
- Guangdong Innovative Enterprise

Industrial control and automation, robotics applications



New energy vehicle electronics applications



Photovoltaic inverter, energy storage and charging applications



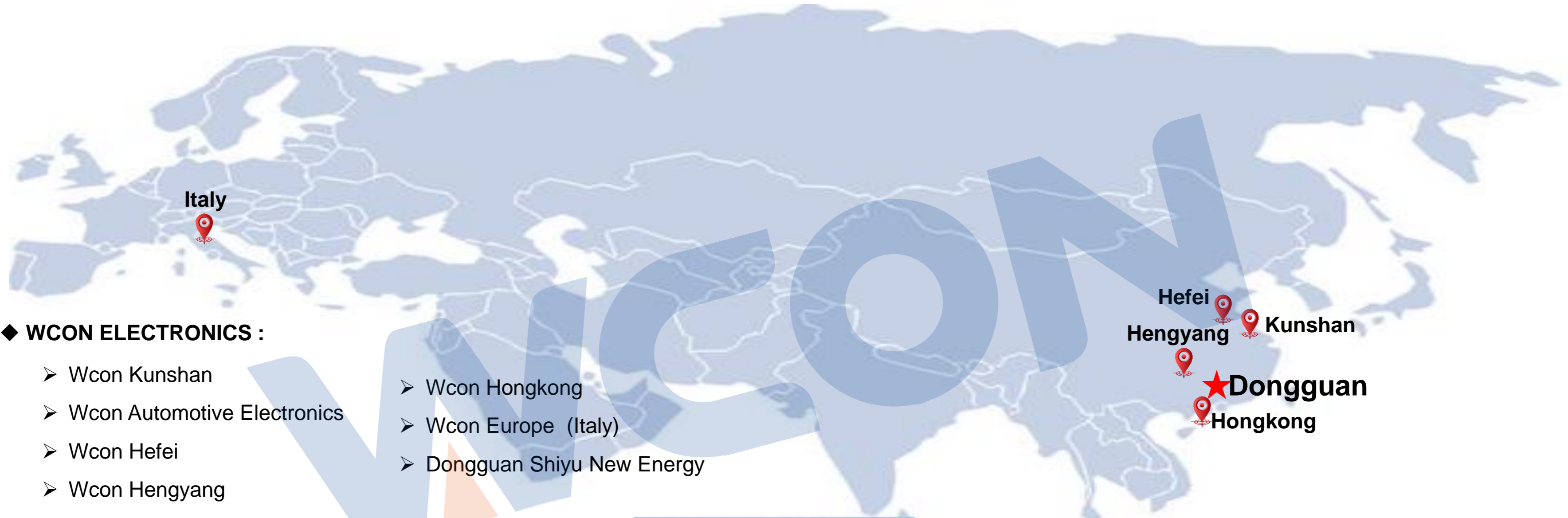

◆ WCON ELECTRONICS :

- Wcon Kunshan
- Wcon Automotive Electronics
- Wcon Hefei
- Wcon Hengyang
- Wcon Hongkong
- Wcon Europe (Italy)
- Dongguan Shiyu New Energy



**WCON
ELECTRONICS
301328**

WCON Electronics (Guangdong) CO.,LTD

Kunshan WCON Electronics CO.,LTD

Hefei WCON Electronics CO.,LTD

WCON Electronics Europe S.R.L (Italy)

Dongguan WCON Automotive Electronics CO.,LTD

WCON Hardware Electronics Limited (Hongkong)

Hengyang WCON Electronics CO.,LTD

Dongguan Shiyu New Energy CO.,LTD

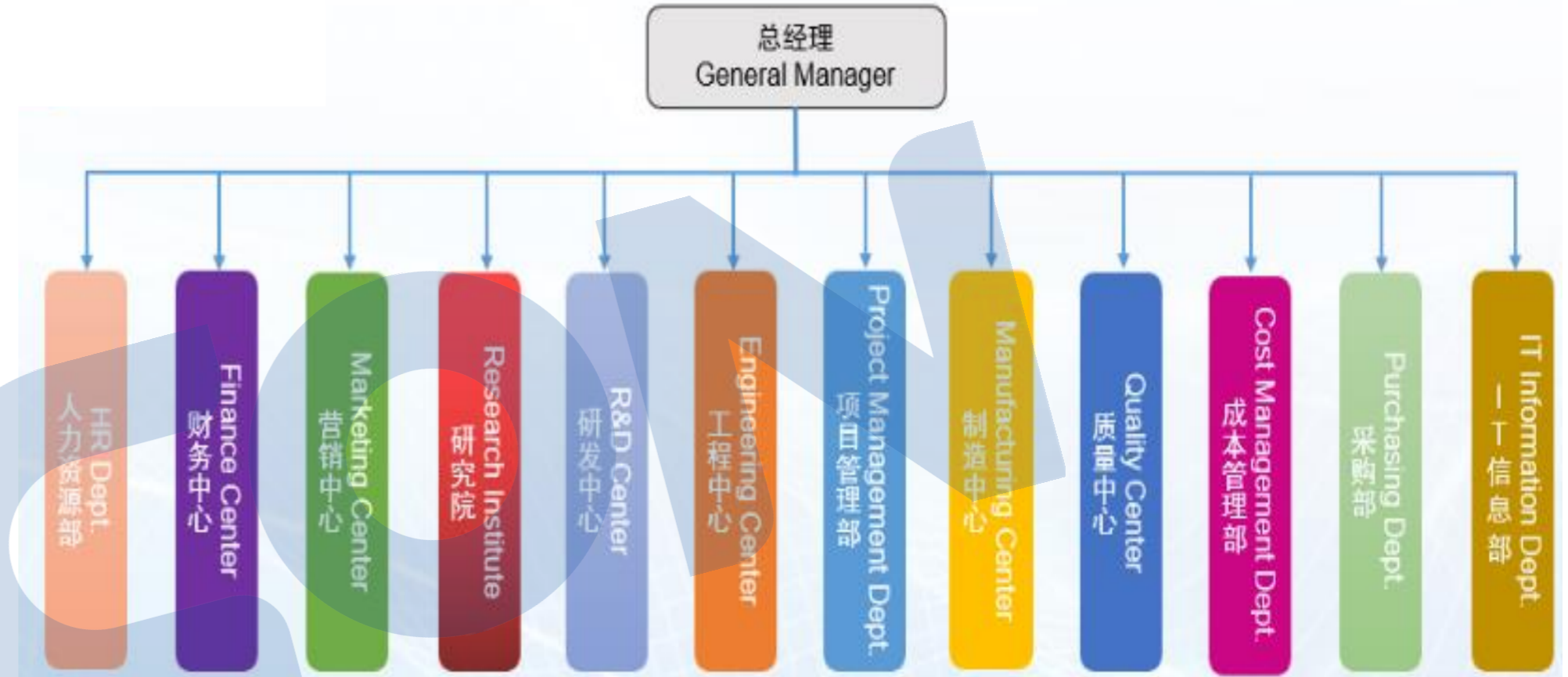

Wcon Electronics Group : 1,500+ Employee

- Wcon headquarters: 1020
- Wcon Automotive: 60
- Wcon Hengyang: 50
- Wcon EE : 1
- Wcon Kunshan:300
- Wcon Hefei: 50
- Dongguan Shiyu New Energy: 30

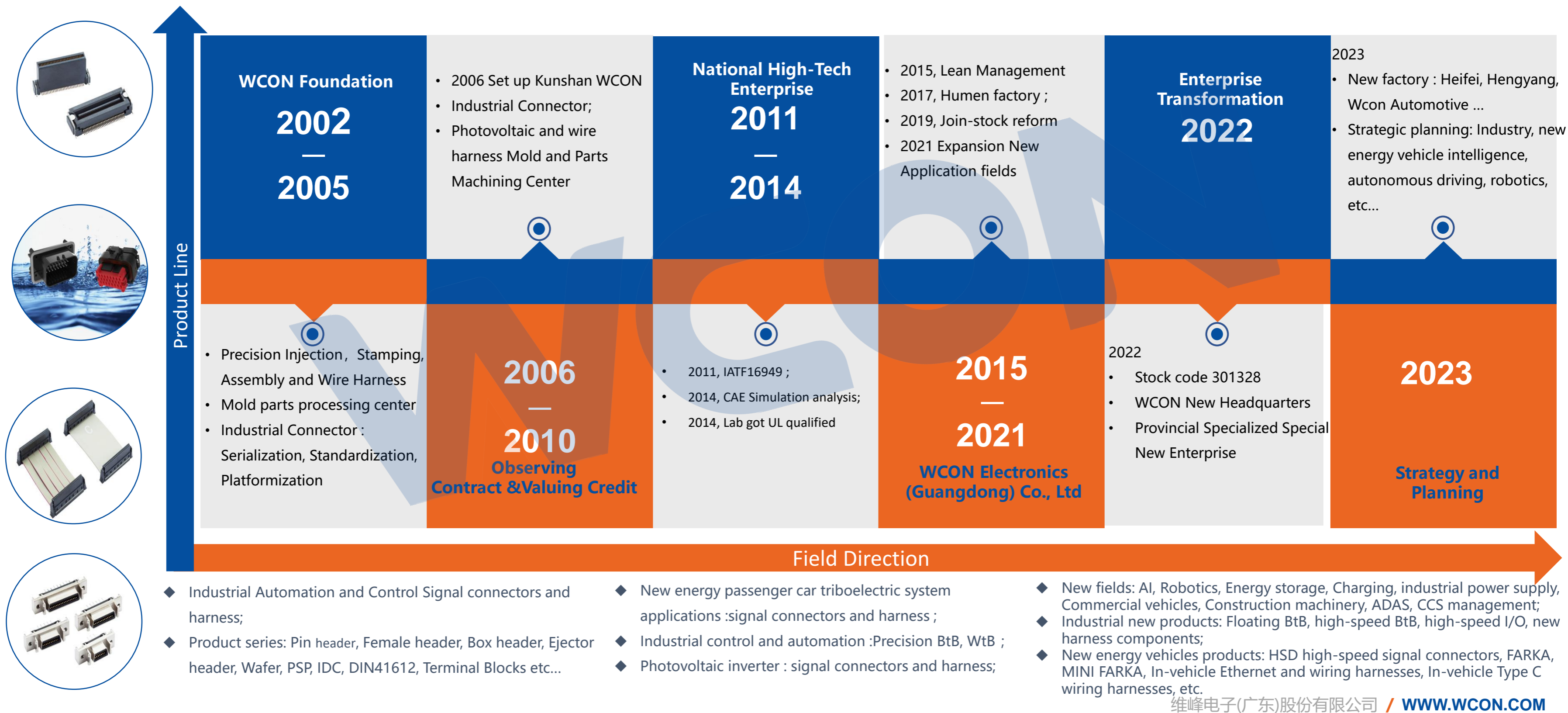

2023

New energy vehicles: Press fit terminal, M50 series, power signal hybrid type, waterproof type, wire-to-wire, floating board-to-board,
Photovoltaic application: Solar photovoltaic C104 series, junction box series
Industrial control: high-speed BTB, WTB, circular connectors
Others: Customized Joined research projects

2024

New energy vehicles: Miniaturized, Integrated, high-performance series connectors; HSD high-speed signal connectors, FAKRA, Mini FAKRA, vehicle Ethernet wire harness, vehicle Type C wire harness, CCS system;
Industrial automation and control: Small pitch, High-speed, Power signal mixed series connectors, etc.
New energy: Small size, High current, Waterproof and anti-UV series connectors, etc.
New fields: Commercial vehicles, Construction machinery, Robots, Energy storage, Charging, power supply, medical care, rail transit, city and building intelligence

202X

- ◆ R&D Team : 70+
- ◆ Research Institute : 7+

Rigorous design procedures, Scientific simulation analysis

- Current-carrying temperature rise simulation
- High-speed high-frequency simulation
- mechanical stress strain

Simulation (CAE) is a sharp tool for product design, product improvement, and product optimization; it provides comprehensive analysis and performance level information, shorten the development cycle and reduce the overall cost of the product.

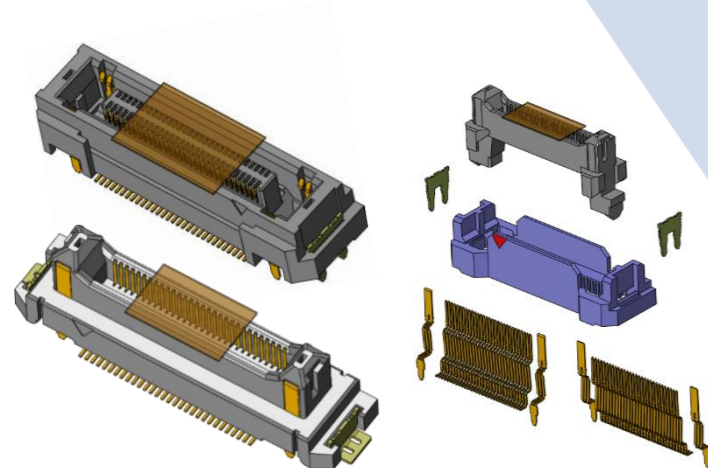

High Precision BTB Project Development

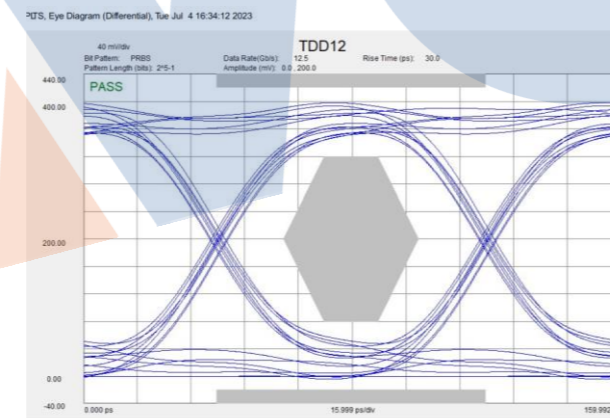

Rigorous Structure Analysis

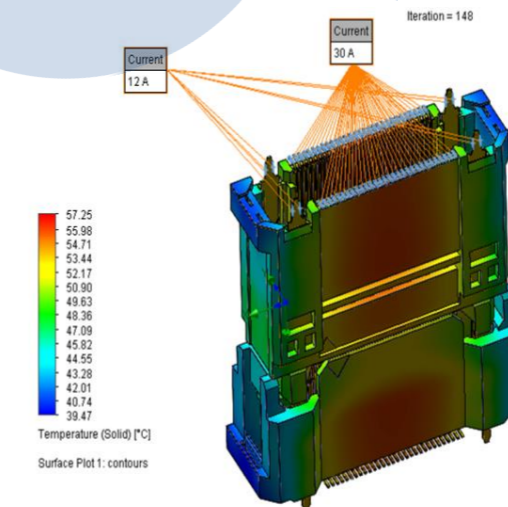

Professional Simulation analysis of Mechanical stress and Temp rise

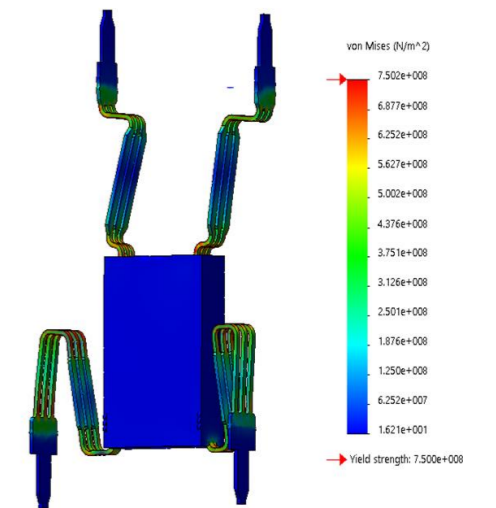

Product Mutual Matching simulation Analysis

◆ 243 Patents

- 30+ Invention patents;
- 50+ Invention patents over the next three years;
- 8 Industry group standards (edited 6 items)

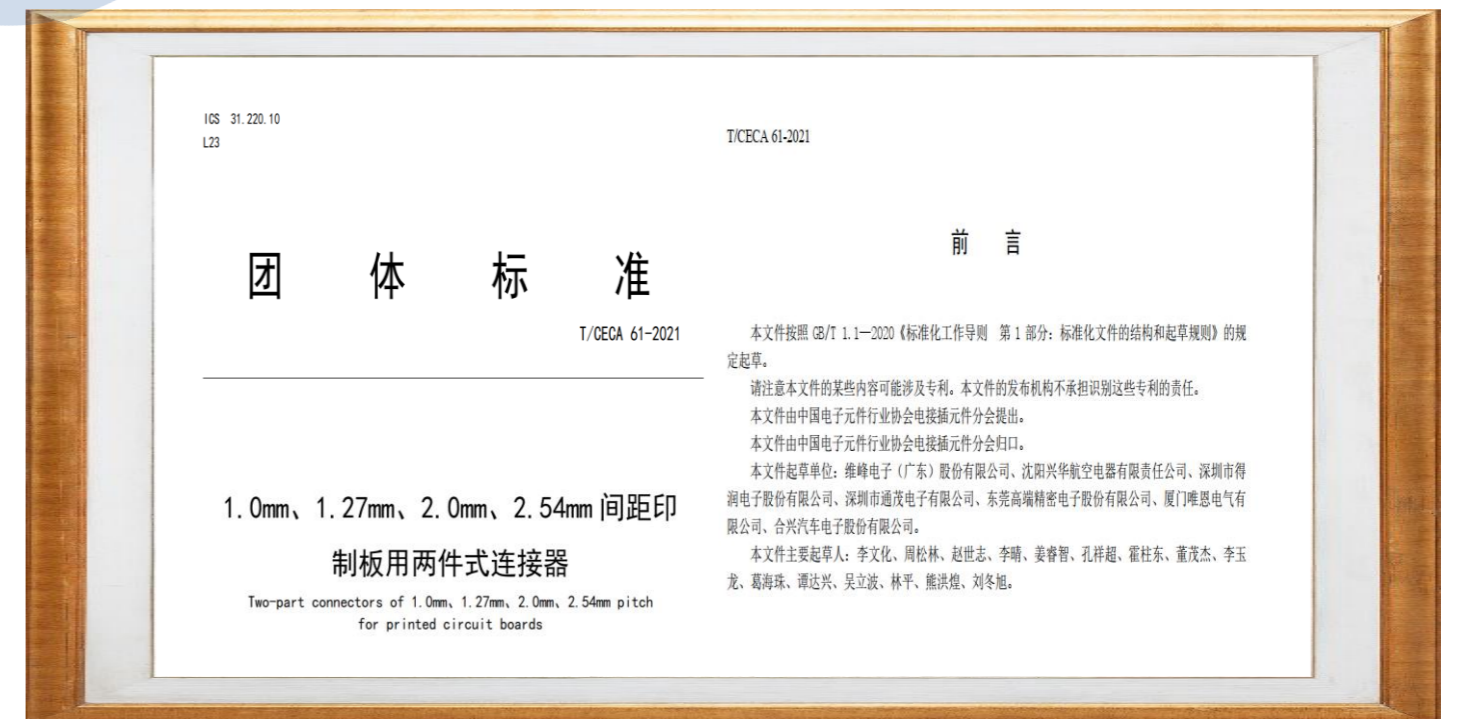
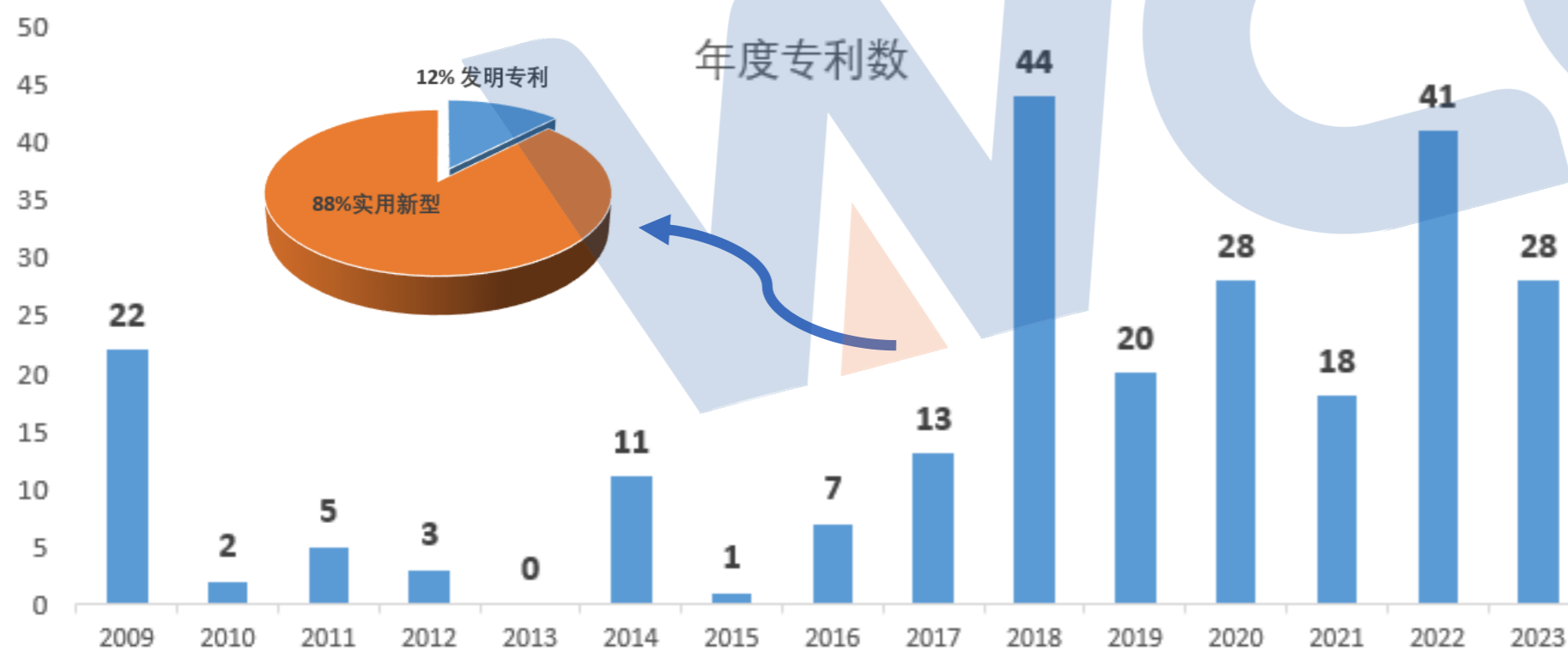

Professional Tooling Design and Fabrication Team: 278

- Mold design: 46 Engineers
- Mold processing: 107 Engineers
- Hardware & injection molding production: 125 Engineers

Using CAD, UGNX (3D), MOLDEX3D, VISI 3D and other software to design precision high-speed metal stamping dies and precision plastic injection molding dies.

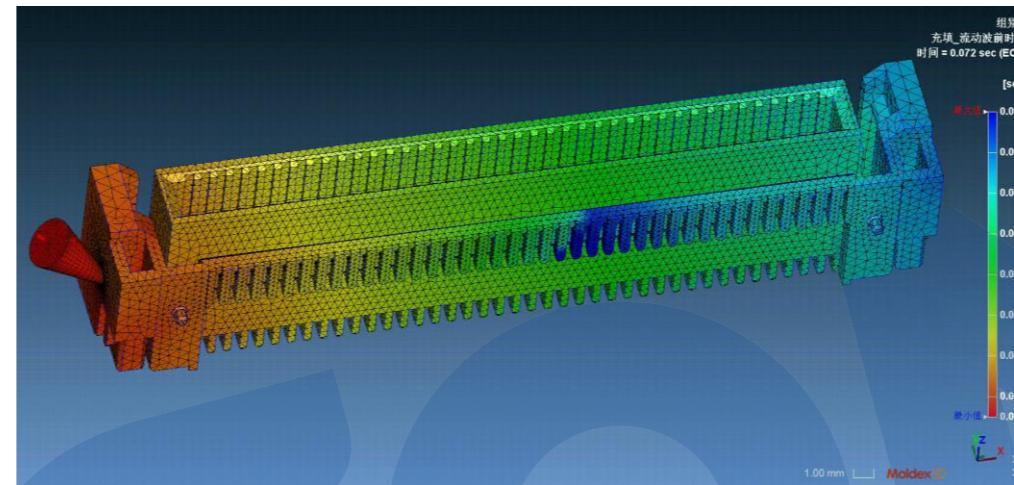

Mold design & Mold Flow Simulation

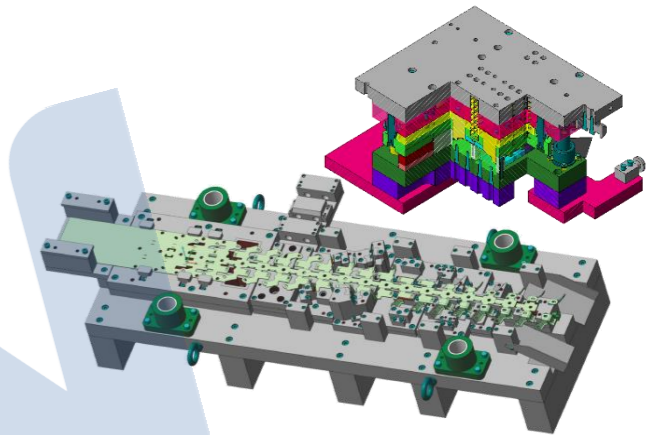

Professional Metal-Die Design & analysis

模号	产品名称	加工工序	加工进度	项目交期
WF17518		中走丝	0%	2021/5/22
WF17518		慢走丝	0%	2021/5/22
WF06119		EDM	16%	2021/5/31
WF20271		磨床	15%	2021/5/21
WF20271		EDM	6%	2021/5/21
WFCM365		中走丝	50%	2021/5/26
WFCM365		CNC	67%	2021/5/26
WFCM365		EDM	28%	2021/5/26
WFCM365		磨床	56%	2021/5/26
WFCM365		慢走丝	55%	2021/5/26
WF04021		慢走丝	8%	2021/5/22
WF13376	0.80mm BTB 90度母座塑胶	EDM	62%	2021/5/19
WF04054		慢走丝	0%	2021/5/21
WF21758	4.19mm 排针塑胶 TYPE-1	磨床	90%	2021/5/22
WF16471	1.27PITCH SDC 母座-180度SMT塑胶...	磨床	85%	2021/5/22
WF21765	4.19mm Housing双排线端主体	EDM	67%	2021/5/22
WF21761	4.19mm 双排 板端母座 主体 带定位柱	中走丝	99%	2021/5/18
WF21761	4.19mm 双排 板端母座 主体 带定位柱	慢走丝	59%	2021/5/18

Advanced Tool production process and schedule management



Tool Solution Analysis

Mold processing equipment : 250 sets

(130 sets in Dongguan, 120 sets in Hengyang and Kunshan):

1. Wire cutting: Shamir, West
2. EDM : Mitsubishi, Makino, Akishimi
3. CNC: Yashida, Micron, Makino
4. Grinding : Mitsui, Okamoto, Yuqing, WAIDA PG optical grinding machine, WAIDA JG coordinate grinding machine
5. Mold material: CD650, ASP23, SKH-9; Viking, SKD61
6. Mold: Rich Bagel plus hard molding die, SLD ultra cryogenic treatment die
7. Current Mold capacity: plastic mold 28 set/month, stamping die 15 sets month
8. New planning, Added two CNC+EDM+ robot automatic mold parts processing lines;
9. Hengyang Factory: Mold processing center and training base for precision mould processing personnel;



Injection Machine: 49

- Horizontal: 7~180 tons;
- Vertical: 35~55tons;
- Brand: Fanuc, Rijing, Baisu
- Mold: 1500+ sets; Mold frame: 100*100 to 500*600
- Mold holes: 2~64 holes
- Capacity: 50M PCS/ month
- Feed: Centralised, single-machine automatic drying and feeding, automatic online crushing cycle

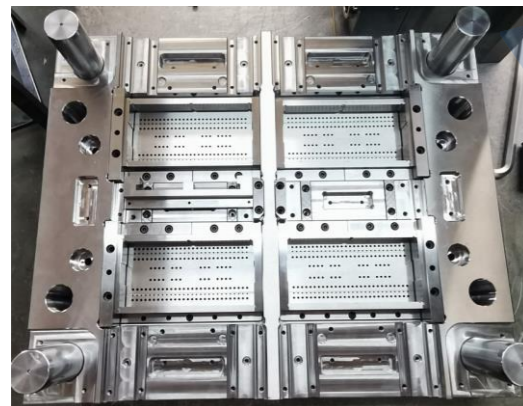

Stamping : 32 sets

- Miniature Press Machine: 3, 5 tons: SPM 500MAX
- High-speed gantry: 20~60 tons: SPM 1500MAX
- Brand: Jingli, Yamada, Boruida
- Accuracy: 1um;
- Material belt: 2 out of 4, internal riveting, two-way
- Mold: 760+ sets
- Capacity: 400 M PCS/ month
- Automation: 100% CCD detection, automatic packaging

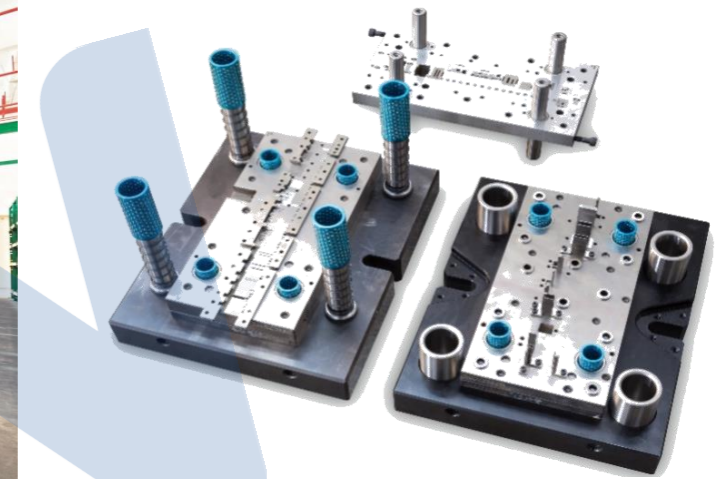

Assembly Machines: 760+

- Fully & semi-automatic assembly machine
- Quality: Professional CCD size and electrical performance detection, automatic classification
- Pass rate: 99.5%
- Flexibilisation: more than 30 manual assembly lines
- Capacity: 40-45M conn./month; Wiring harness 0.5M/month
- Features: Variegation, Small batch, High quality, Consistency, Stability
- Professional management: Separate production areas and specialised process management in accordance with product range and characteristic requirements



- Perfect quality system, All-round quality assurance
- **CNAS Laboratories** (Expected 2024)
- Adequate testing equipment: material analysis, environmental testing, electrical , mechanical and environmental characteristics, failure analysis, dimensional measurement, etc.



ISO 9001



IATF 16949



ISO 14001



邓白氏体系认证
54-484-5969

1. Material analysis:

Moisture analyzer, melt index tester, Vickers hardness tester, X-ray spectrometer, infrared spectrometer Nicolet is50, film thickness tester (0.01um);

2. Environmental testing:

SEA100A (Pb,Cd,Hg,Cr,Cl), GC-MS (ROHS2.0 polybrominated biphenyl);

3. Electrical characteristics:

Voltage/brilliant tester (5%), four-wire resistance meter RM3545(±0.006%, 0.01uΩ), micro-resistance tester (±0.05%), contact resistance tester (0.01uΩ), multi-channel temperature tester 10 sets (±0.05 °C), digital multimeter (0.5%~0.8%), contact voltage drop tester, dynamic resistance tester, programmable DC power supply 10 sets, network analyzer;

4. Mechanical characteristics:

Instantaneous breaking meter, electromagnetic vibration meter, mechanical impact tester, drop tester, metal tensile tester, rotary tensile tester, automatic inserting and pulling force tester (each class), belt stripping force tester (each class), torque wrench tester (dial type, automatic type, ordinary type);

5. Environmental characteristics:

Steam aging test machine, alternating salt spray test box, reflow welding simulation tester, constant temperature and humidity test instrument, rapid change of hot and cold shock tester (10S), high temperature aging test box, hot wire tester (±5°C ±0.1S) , waterproof tester (IPX9K), reflow welding, air tightness tester, dust proof test box, horizontal and vertical combustion tester, needle flame tester

6. Failure analysis:

VHX-7000 ultra HD microscope, EVO18 scanning electron microscope, temperature, humidity and vibration three comprehensive testing machine, polishing grinder, metallographic cutting grinder,

Dimension measurement: three dimensional (2 sets), 2.5 dimensional, 2 dimensional (15 sets), dynamic warping analyzer, caliper (300+), micrometer, micrometer, height gauge, etc. The highest comprehensive measurement accuracy is 1um;



Microwave Network Analyzer

- High frequency test from 900 Hz/10 MHz~43.5 GHz
- Two signal sources 4 ports



Fisher X-Ray

- Plating thickness test and guarantee;
- The minimum measuring point @0.1mm;



Instantaneous break detector:

- Simulation testing in vibration environment of automobile, construction machinery etc.;
- Test range: 1Ω ~ 20KΩ;
- Test range: 0.1μs - 100μs



Infrared spectrometer



Ultra HD microscope



EVO 18 SEM



Temperature, Humidity and Vibration Comprehensive Tester



GC-MS test equipment

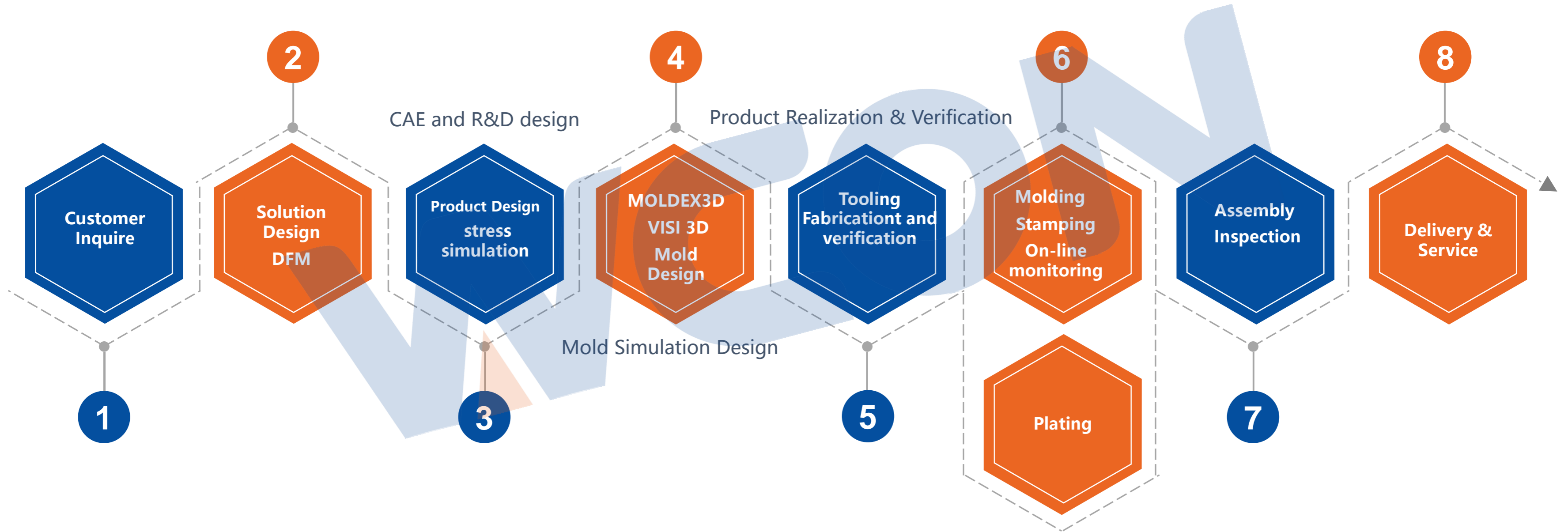

Automotive:

- Three electric, ADAS, intelligent cockpit, internal connection;
- Passenger Cars
- Engineering Vehicles
- Construction Machinery
- Agricultural Machinery
- Intelligent Logistics handling

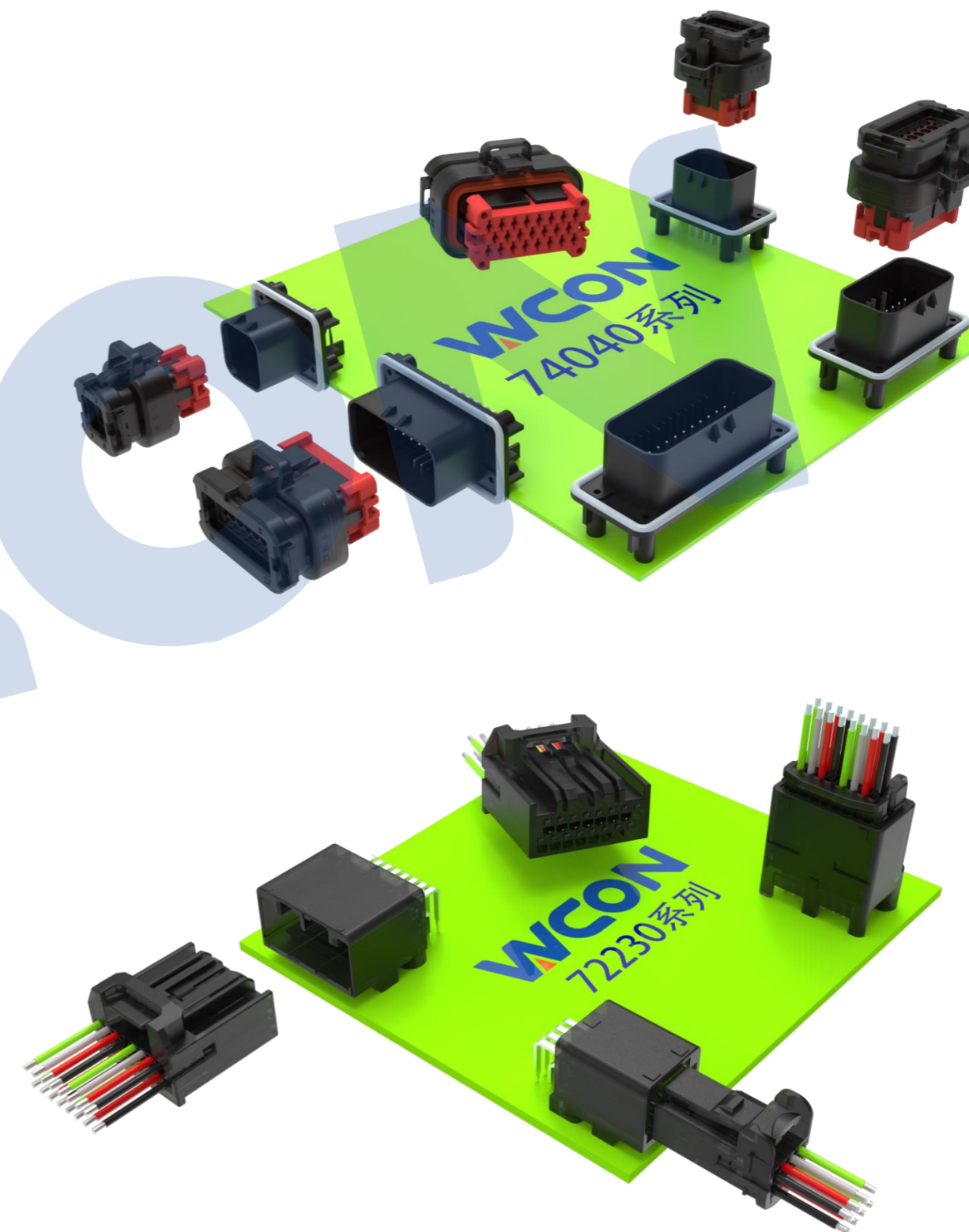

Passenger Car

- BMS,OBC,ECU
- ADAS
- Smart cockpit connectivity

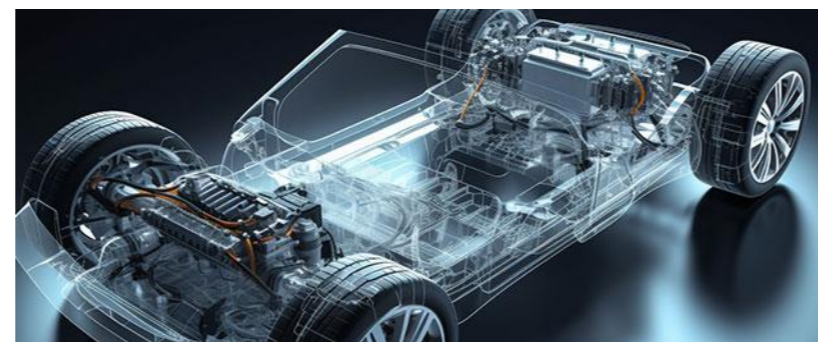

Product Selection

Wire to Board Series

74040、73742、73040、72544、73036、
72230、72230A、F3911、75263、75250、75240、
72525、72040、72022、72000、72025、72025A、
72001、74001、3915、3918、3618、WF2508、
WF2509、WF2011、WF2012、WF2010、WF1258;

Board to Board Series

3910、21F62、3623

Customized Series

Pin header, Wire to Board connector, Board to Board connector



Bus

- BMS, CCS



Engineering vehicles and machinery

- Controller



Industrial Automation and Control System

- PLC、IPC
- Industrial intelligent equipment



Industrial Robot

- Industrial robot arm
- Motion control box

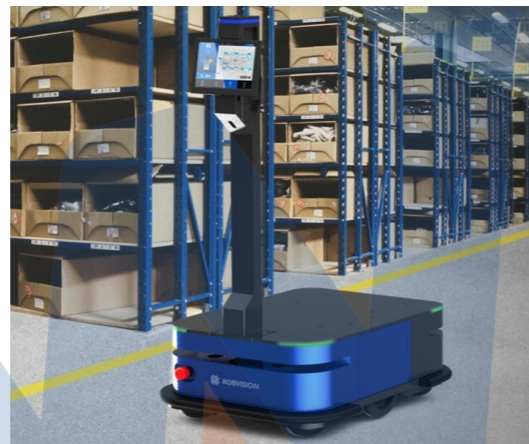

Smart city

- Smart buildings and elevators
- Commercial server



Product Selection

1. Pin HDR and Female HDF Connector
2. Box Header and Ejector Header Connector
3. BTB Free-High Connector
4. WD&WF connector
5. IDC, FFC, FPC Connector
6. Micro I/O Connector
7. PSP、DIN41612 Connector
8. M8、M12、HDC Connector
9. Motor and machine Connector
10. Wire Harness & Flat Cable

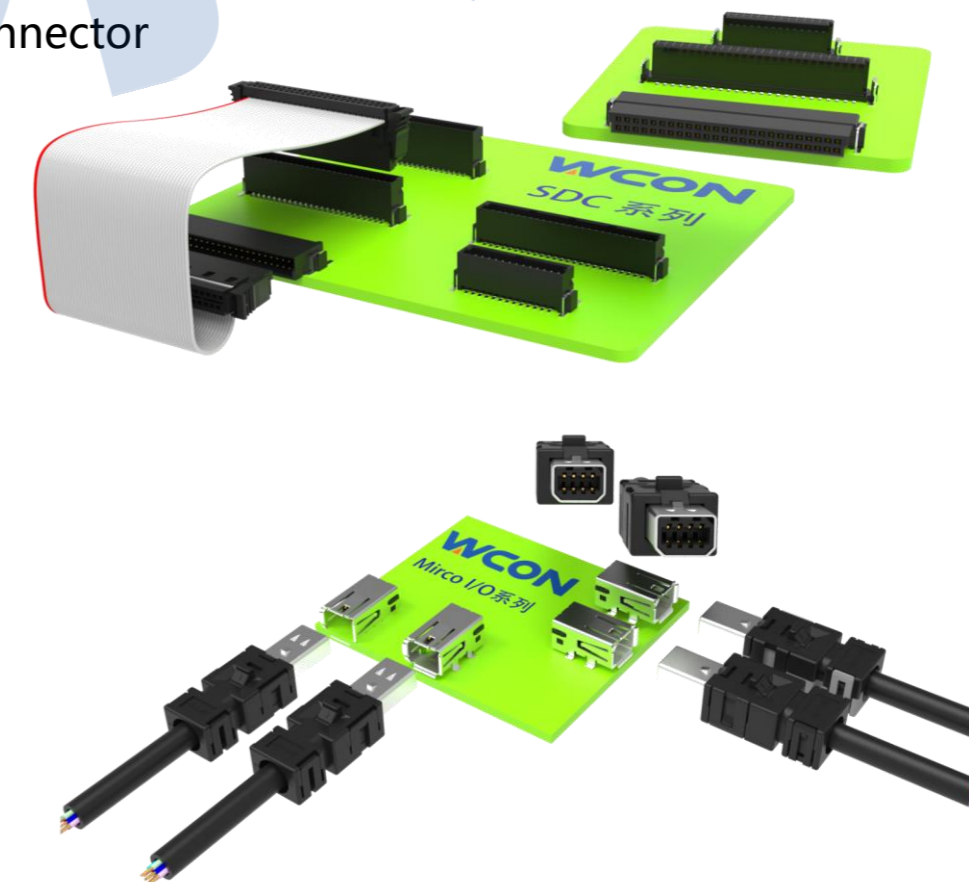

Photovoltaics

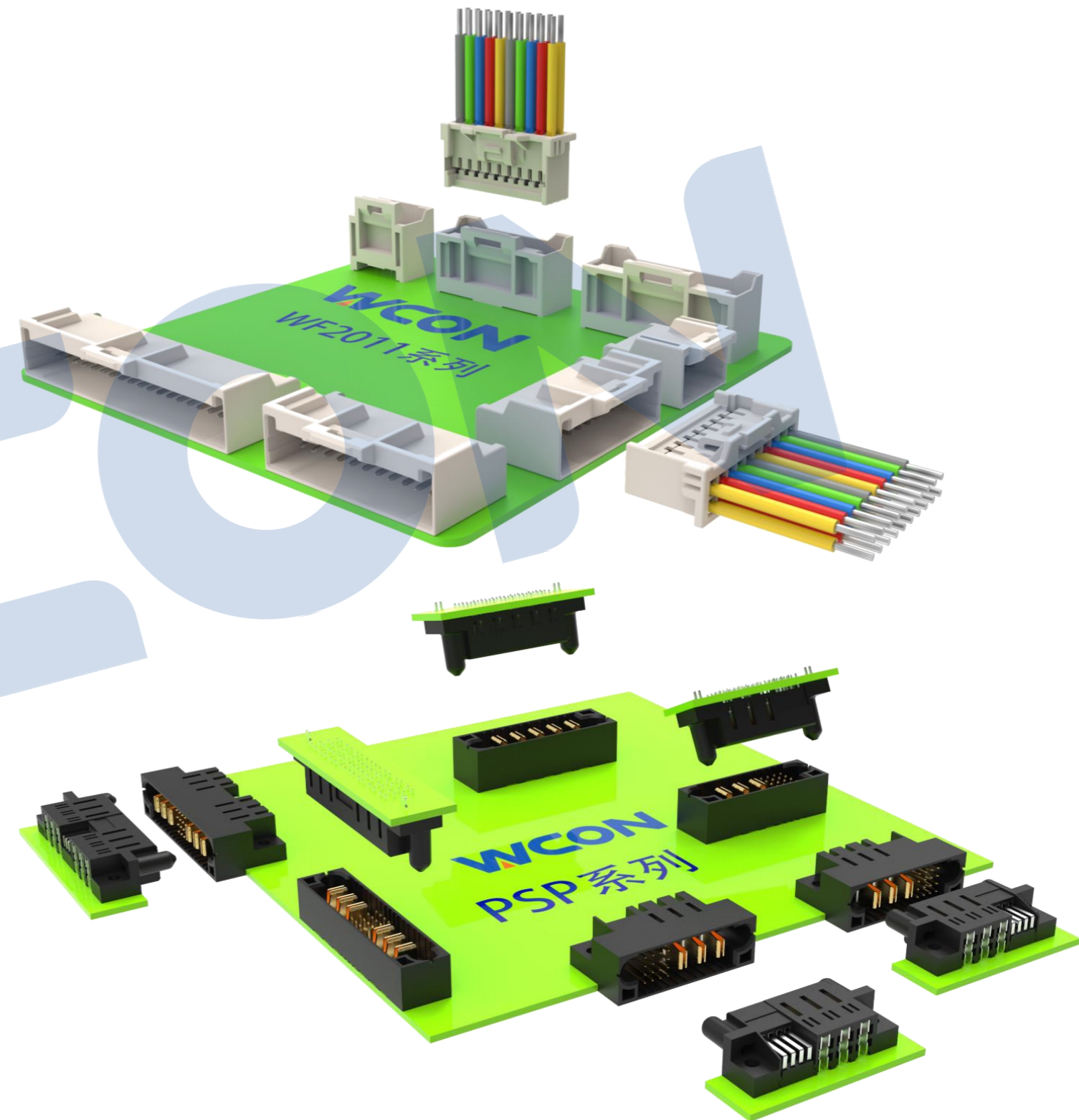

Energy Storage,

Charging and Power

Strategic Partners & Revenue

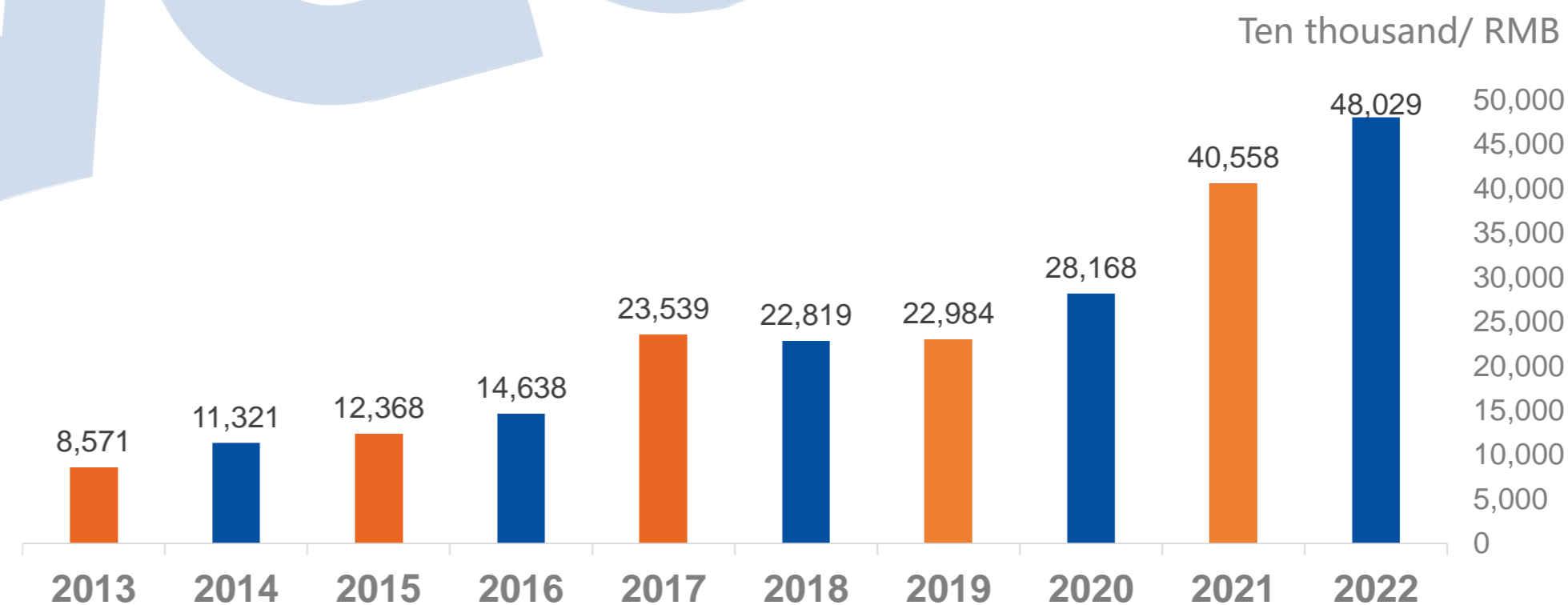
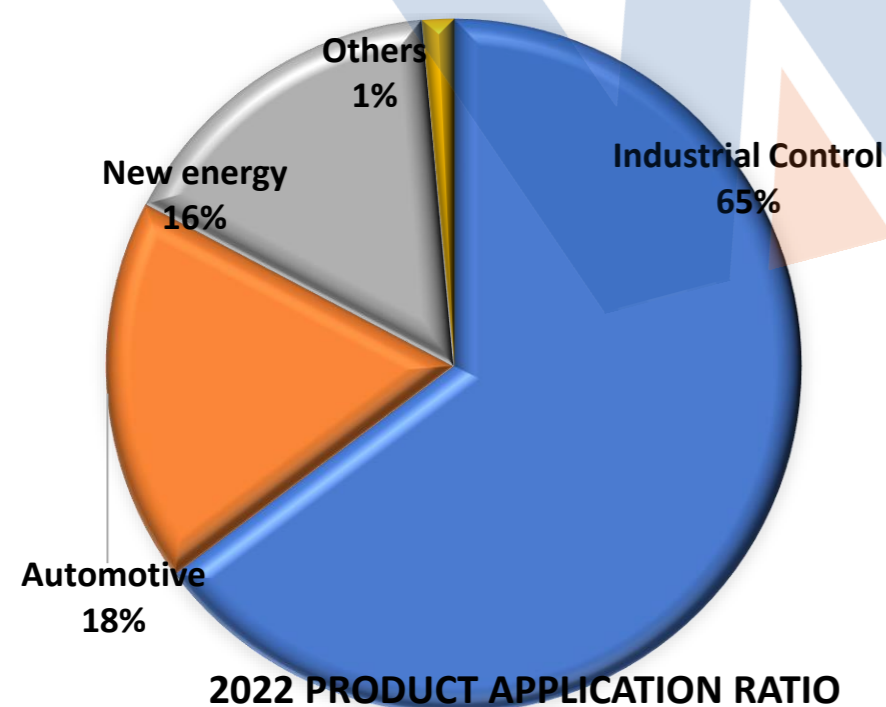
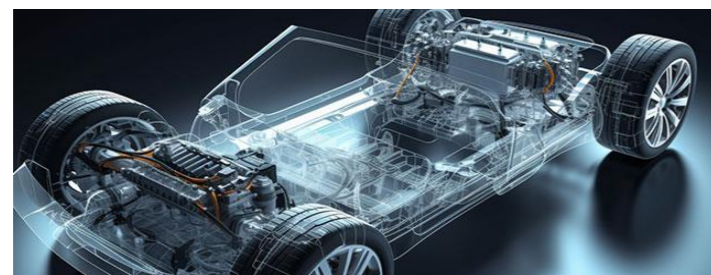



➤ **Fast delivery:** Local production, Short LT, Fast Logistics.



➤ **Strong Technique:** Full categories, International Brand substitution, Own property rights, Optimization and upgrading



➤ **Unification of Standards:** Integration of the three major international automotive standards QC/T1067, USCAR, LV214



➤ **Quality Assurance** : Recognized by many OEMs and Tier-1s.



➤ **Quality service** , Flexible service , fast action



➤ **Localization**, Creating higher value for customers and achieving win-win situation.





WCON ELECTRONICS (GUANGDONG) CO.,LTD (HQ)

Add :No.7,Changxing Road, Ludong,Humen Town,
Dongguan City, Guangdong Province .523935, China

Tel: +86-769-8535 8920

Fax: +86-769-8535 8915

Http: www.wcon.com

South China Sales Dept E-mail:

mktgdg@wcon.com

salesdg28@wcon.com

salesdg21@wcon.com

Int' l Sales Dept E-mail :

Salesdg01@wcon.com

KUNSHAN WCON ELECTRONCIS CO.,LTD (East of China)

Add : No.321, Xinhong Road, Shipu, Qiandeng
Town, Kunshan, Jiangsu, China

Tel: +86-512-5746 8408

Sales Dept E-mail:

Salesks@wcon.com ; Salesks01@wcon.com

HEFEI WCON ELECTRONCIS CO.,LTD

Add : 2F, Building E, Greentown Science Park,
High-tech Development Zone, Hefei, Anhui,
China

Tel: + 86-551-6288 2325

Sales Dept E-mail: wconhf@wcon.com

WCON ELECTRONICS EUROPE S.R.L. (Europe)

Add: Via dei Mille 8020861 Brugherio (MB) Italy

Tel.: +39 039 677 4129

Contact: Mr. Alberto Quadrio

E-mail: alberto.quadrio@wcon.com

DONGGUAN WCON AUTOMOTIVE ELECTRONCIS CO.,LTD

Add :No.7,Changxing Road, Ludong,Humen Town,
Dongguan City, Guangdong Province .523935,
China

Tel: +86-769-8535 8920

E-mail: salesauto01@wcon.com