

HSF

NOTES:

Current rating: 0.5AMP
 Voltage rating: 50V
 Contact resistance: 100mΩ Max
 Withstand voltage: 250V AC
 Insulation resistance: 500MΩ Min
 Temperature range: -40℃ to +105℃
 Contact material: copper alloy
 Contact plating:
 xxu" gold on contact area (see ordering information)
 3u" gold on solder area (ASTM B 488)
 80u" nickel underplating overall (ASTM B 733)
 Hold-down material: copper alloy
 Hold-down plating:
 80u" tin plating over all the pins.
 40u" nickel underplating overall. (ASTM B 733)
 Housing material: grass filled plastics; Black UL94V-0
 Cap material: grass filled plastics; White UL94V-0
 IR soldering, Peak temperature: 260±5℃, 5s ;

Ordering Information

3618 - P XXX -109 M XX R 01

No. of pins:
 030=30Pin
 120=120Pin
 (See Table 1)
 Housing height:
 109=10.95mm
 130=13.05mm
 145=14.55mm
 158=15.8mm
 197=19.75mm

Packing:
 R=Tape&Reel+cap
 Contact plating:
 G1=3u" Gold
 G2=5u" Gold
 G3=10u" Gold
 G4=15u" Gold
 G5=30u" Gold

Table 1:

No. of pins:	A	B	C	D	E
30	14.4	11.2	16.3	15.0	16.16
40	18.4	15.2	20.3	19.0	20.16

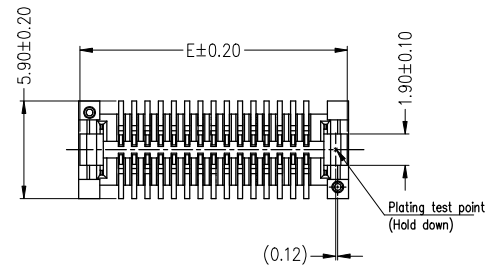
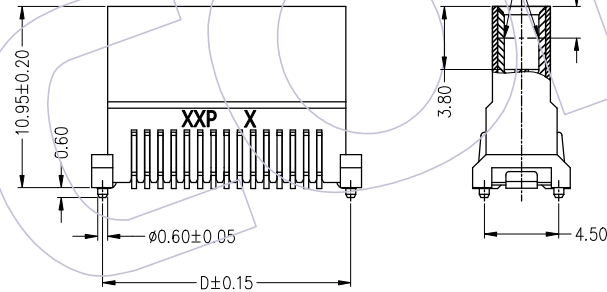
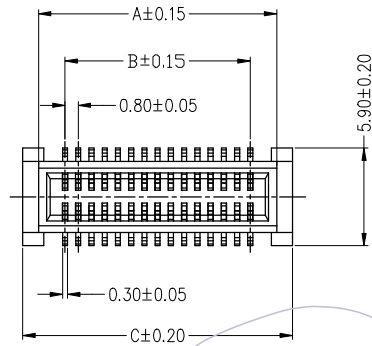
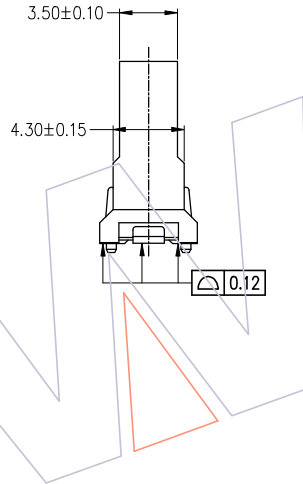
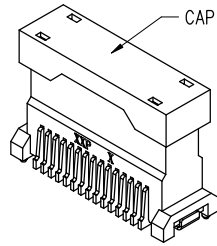

Recommended P.C.B layout (Top side)
 (PCB board tolerance ±0.05)

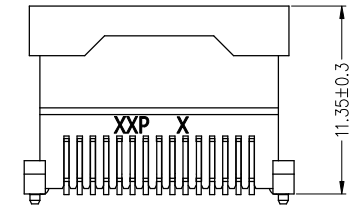
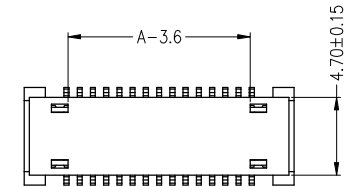
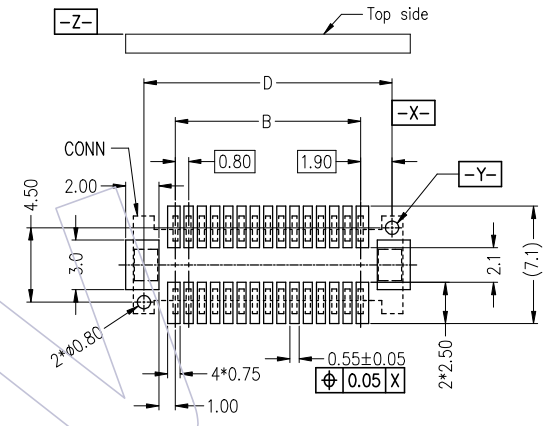

Table 2:

Item	Pitch	Mating
Standard	0.80	3618-SXXX

Rev	Date	Modification scription	Change	Operation		Draw	Date	FIT	Part No.
				DIM	TOL				
01	2021/03/22	NEW	-----	x.X	±0.40	XIAOBING YE	2021/03/22	mm	3618-PXXX-109MXXR01
				x.XX	±0.35	Check	Date	A4	Title:
				x.XXX	±0.15	Approve	Date	1/1	0.8mm Board To Board conn. Plug SMT Type H=10.95mm
				Angle	± 3°			PROJ.	Customer No.

WCON

Http: www.wcon.com

WCON-Dongguan
 Tel: +86 769 85358920
 Fax: +86 769 85358915
 E-mail: sales@wcon.com

WCON-Kunshan
 Tel: +86 512 57468408
 Fax: +86 512 57468468
 E-mail: salesks@wcon.com