

HSF

NOTES:
 Rated Current:2.0AMP
 Contact Resistance:20mΩ max
 Withstand Voltage:500V AC
 Insulation Resistance:1000MΩ min
 Operation Temperature:-40°C to +105°C

Contact Material:Phosphor Bronze
 Contact Plating:Au Or Sn Over Ni
 Insulator Material:PA9T+33%G.F UL94V-0

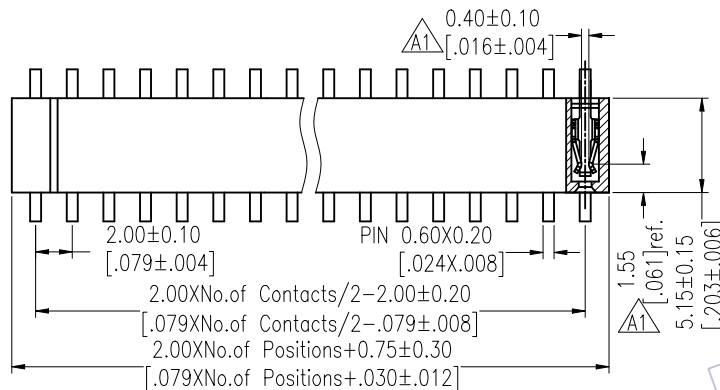

Recommended P.C.B Layout(Top Side)
 (PCB BOARD TOLERANCE±0.05)

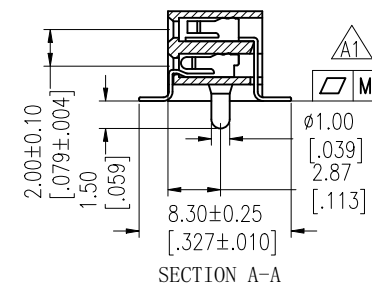
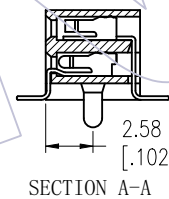
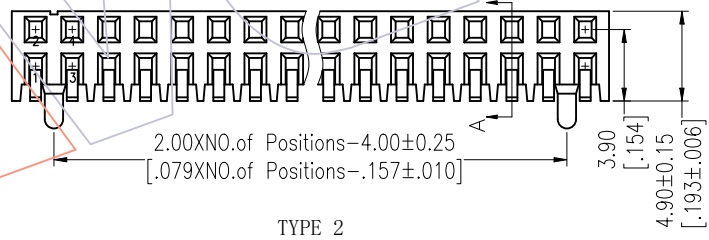
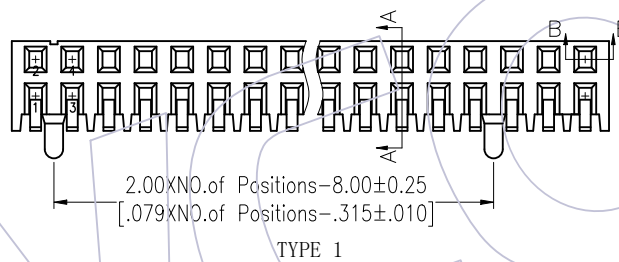
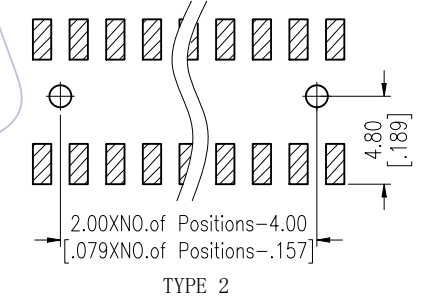
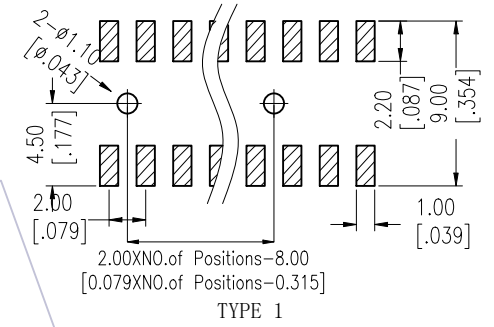

Ordering Information

2249 - 2 XX M XX CUNT X

- No. of Pins per Row: 02-40Pin
- Contact Plating:
 G0=Gold Flash
 G3=10μ"Gold
 G4=15μ"Gold
 G5=30μ"Gold
 S0=Gold Flash/Tin
 S3=10μ"Gold/Tin
 S4=15μ"Gold/Tin
 S5=30μ"Gold/Tin
 SN=Tin
 SM=Matte Tin
- Packing:
 T=Tube
 P=Tube+CAP
 R=Tube&Reel+CAP
- Series No.
 2=TYPE 1
 3=TYPE 2

Item	Pitch	Mating
Standard	2.00	1215/1220
Alternate		

[A1] Pin(Per Row)	2-15P	16-25P	26-40P
M	0.10	0.15	0.20

TITLE	PART NO.
TYPE 1	2249-2XXMXXCUNT2
TYPE 2	2249-2XXMXXCUNT3

OPERATION	DRAW	DATE	SCALE	FIT	PART NO.
X.X ±0.40	JYHuang	2023/02/14	UNIT mm		SEE TABLE
X.XX ±0.25	CHECK	DATE	SIZE A4		TITLE: 2.0mm Female Header DUAL ROW 180° SMT SIDE INSERT WITH POST H=4.9
X.XXX ±0.15	APPROVE	DATE	SHEET 1/1		Customer NO.
Angle ± 3'			PROJ.		
DIM TOL					

WCON
 Http: www.wcon.com

WCON-Dongguan
 Tel: +86 769 85358920
 Fax: +86 769 85358915
 E-mail: sales@wcon.com

WCON-Kunshan
 Tel: +86 512 57468408
 Fax: +86 512 57468468
 E-mail: salesks@wcon.com