

# HSF

**NOTES:**  
 Rated Current: 7.0AMP.  
 Contact Resistance: 15mΩ Max.  
 Rated Voltage: 1000V AC  
 Operation Temperature: -40°C to +125°C

Contact Material: Brass  
 Contact Plating: Au or Sn Over Ni  
 Insulator Body Material: PA9T UL94V-0 BK

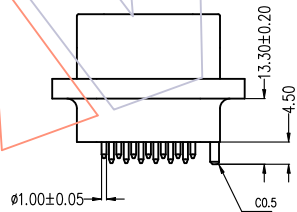
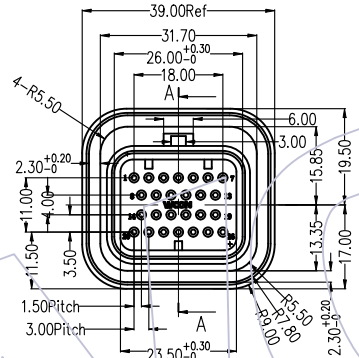
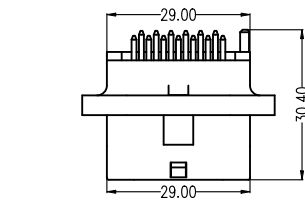
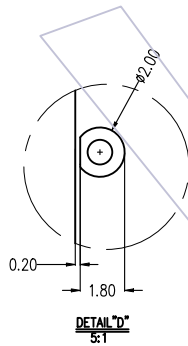
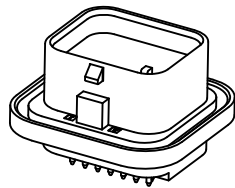

## Ordering Information

7 30 40 - 4 M S 026 C B XX X A X W

4: Four Row  
 M: Male  
 S: 180°  
 No. of pins  
 026=26P  
 034=34P  
 Insulator Material  
 C=PA9T  
 B: Brass  
 W: Witch WCON LOGO  
 X: 1, 2, 3 ... wrial number  
 A: Vacuum box  
 B: Don't glue  
 D: glue  
 Contact Plating  
 S4=15u"Gold/ Matte Tin

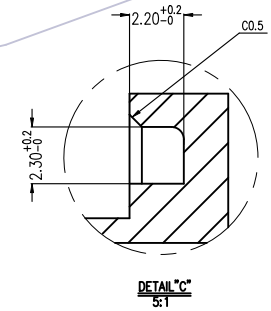
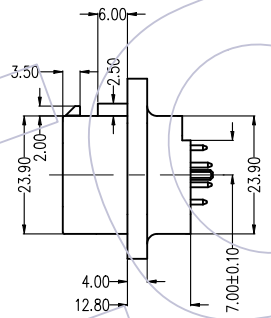

## Recommended P.C.B Layout (Top Side) (PCB BOARD TOLERANCE ±0.05)

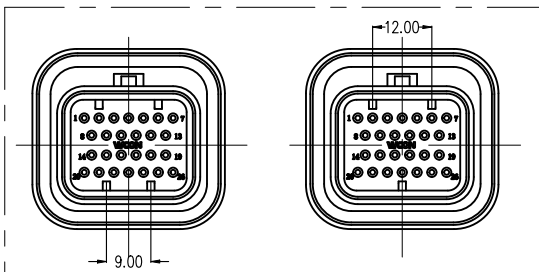
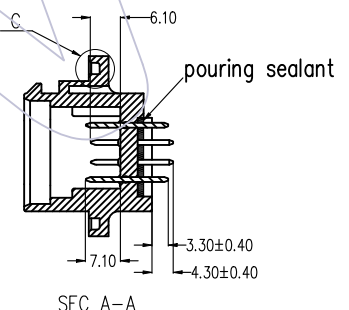
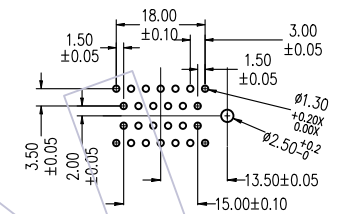

73040-4MS026CBS4DA1W 73040-4MS026CBS4DA2W

REV	DATE	MODIFICATION DESCRIPTION	CHANGE	OPERATION	DRAW	DATE	SCALE	Fit	PART NO.
				X. ±0.60	kevin-xin	2023/07/20	UNIT	mm [inch]	73040-4MS026CBS4DAXW
A1	2023/07/20	Update material code	-----	X.X ±0.40	CHECK	DATE	SIZE	A4	TITLE: 3.0X4.0mm Pitch, 26P 180° SUPER SEAL CONNECTOR
A0	2021/10/26	NEW	-----	X.XX ±0.25	APPROVE	DATE	SHEET	1/1	Customer NO.
				Angle ± 3'			PROJ.		
				DIM	TOL				

# WCON

Http: [www.wcon.com](http://www.wcon.com)  
 WCON-Dongguan WCON-Kunshan  
 Tel: +86 769 85358920 Tel: +86 512 57468408  
 Fax: +86 769 85358915 Fax: +86 512 57468468  
 E-mail: [sales@wcon.com](mailto:sales@wcon.com) E-mail: [salesks@wcon.com](mailto:salesks@wcon.com)