

NOTES:

Rated Current:15.0 AMP
 Contact Resistance:8 mΩ Max
 Withstand Voltage:2000 V AC/DC
 Insulation Resistance:1000 MΩ min
 Operation Temperature:-40°C to +105°C
 Wire Range:30~12 AWG
 Wire Strip Length: 7 mm
 No.of Positions:2~20
 Screw Counter Torsion Force: 4.4 lbf.in Min.

Terminal Material:Phosphor Bronze
 Terminal Plating:Matte Tin Plated Over Nickel
 Pin Block Material:Brass
 Pin Block Plating:Nickel Plated Over All
 Screw Material: Steel
 Screw Plating:Nickel Plated Over All
 Up Cover Material:PA66 UL94 V-0
 Below Cover Material:PA66 UL94 V-0

Ordering Information:

P F 750 - A XX A SM N 1 N

F=Female Pitch 750=7.50 No. of Pins 02-20P Contact Plated SM=Matte Tin Blank=W/T WCON N=W/O WCON
 Color A=Green Type N=W/O Screw

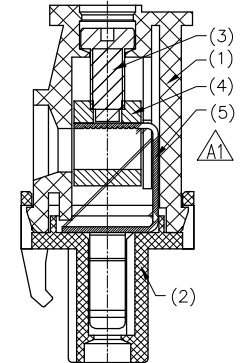
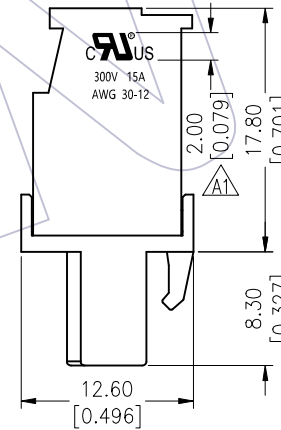
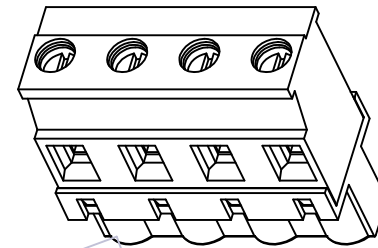
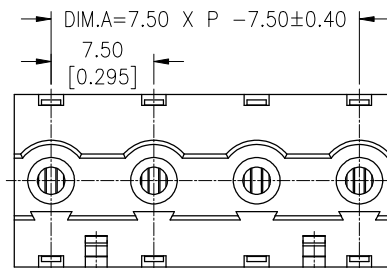
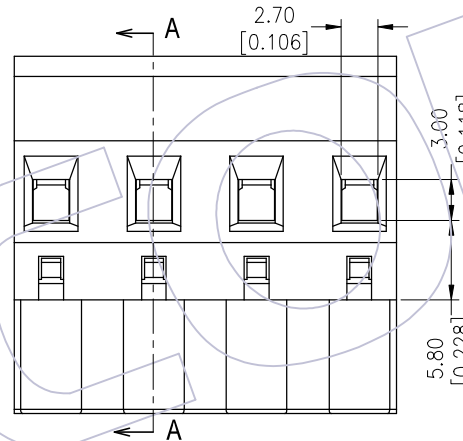
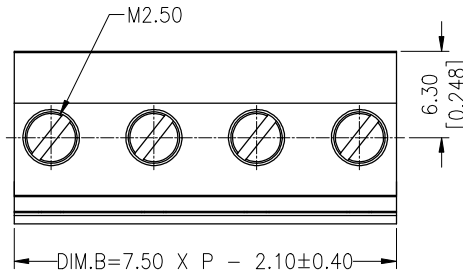
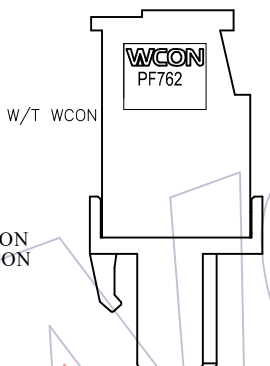
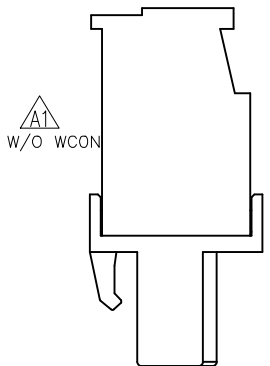

PIN	DIM.A	DIM.B	PIN	DIM.A	DIM.B
02	7.50	12.90	12	82.50	87.90
03	15.00	20.40	13	90.00	95.40
04	22.50	27.90	14	97.50	102.90
05	30.00	35.40	15	105.00	110.40
06	37.50	42.90	16	112.50	117.90
07	45.00	50.40	17	120.00	125.40
08	52.50	57.90	18	127.50	132.90
09	60.00	65.40	19	135.00	140.40
10	67.50	72.90	20	142.50	147.90
11	75.00	80.40			

ITEM	TITLE	P/N	Q'TY	Material
(5)	Contact	TPT051-PSM001	N	C5191R-H T=0.4
(4)	Pin Block	BL025-1SN101	N	C3604
(3)	Screw	MA025-1SXX01	N	C1018
(2)	Cover	HPC750-XXB1AN2	1	PA66 UL94-V0
(1)	Housing	HPF750-XXB1AN2(N)	1	PA66 UL94-V0

REV	DATE	MODIFICATION DESCRIPTION	CHANGE	OPERATION	DRAW	DATE	SCALE	FIT	PART NO.
				x.x	±0.40	2020/12/25	UNIT	mm	PF750-AXXASM1(N) A1
A1	2020/12/25	ADD LOGO;ADD W/O WCON LOGO P/N	XSR	x.xx	±0.25	DATE	SIZE	inch	TITLE:
A0	2013/11/08	NEW		x.xxx	±0.15	DATE	SHEET	A4	7.50mm Pitch Female Pluggable Terminal Blocks
				Angle	± 3'	DATE	PROJ.	1/1	Customer NO.
				DIM	TOL				

WCON
 Http: www.wcon.com

WCON-Dongguan Tel: +86 769 85358920 Fax: +86 769 85358915 E-mail: sales@wcon.com
 WCON-Kunshan Tel: +86 512 57468408 Fax: +86 512 57468468 E-mail: salesks@wcon.com