

HSF

NOTES:

- Rated Current: 3.0AMP.(20°C,3*2P-3*15P)
2.0AMP.(20°C,3*16P-3*40P) $\triangle A4$
- Contact Resistance: 20m Ω Max.
- Withstand Voltage: 500V AC/DC
- Insulation Resistance: 1000M Ω Min.
- Operation Temperature: -40°C to +125°C(Gold Plating) $\triangle A2$
-40°C to +105°C(Tin Plating)
- Contact Material: Copper Alloy
- Contact Plating: Au or Sn Over 30u" Min Ni $\triangle A4$
- Insulator Material: PA9T+G.F UL94V-0 BK $\triangle A4$

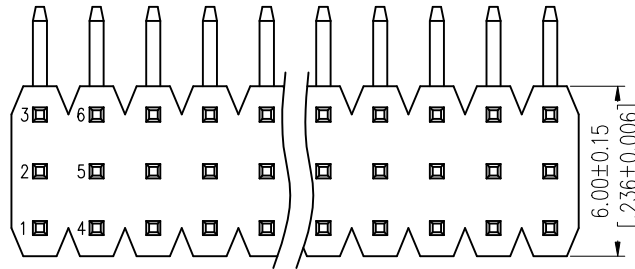

Recommended P.C.B Layout (Top Side)
(PCB BOARD TOLERANCE ± 0.05)
(PCB Thickness: T=1.60mm)

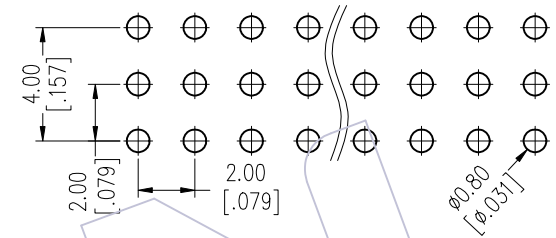

Ordering Information

1215- 2 3 XX XX R XXX C 0 XX $\triangle A1$

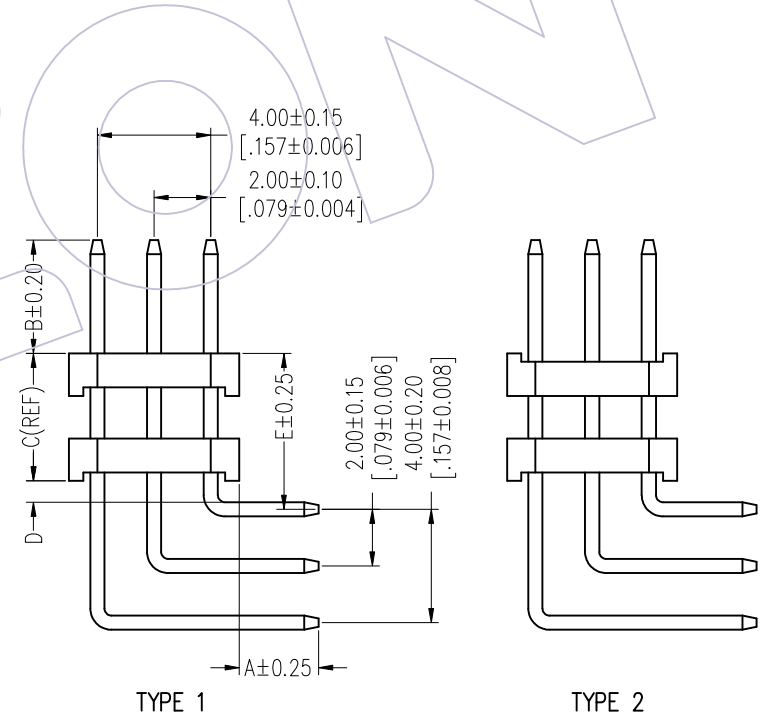
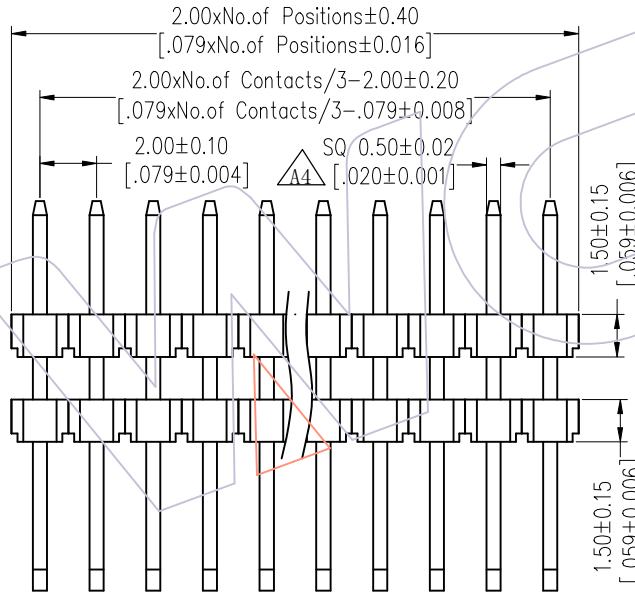
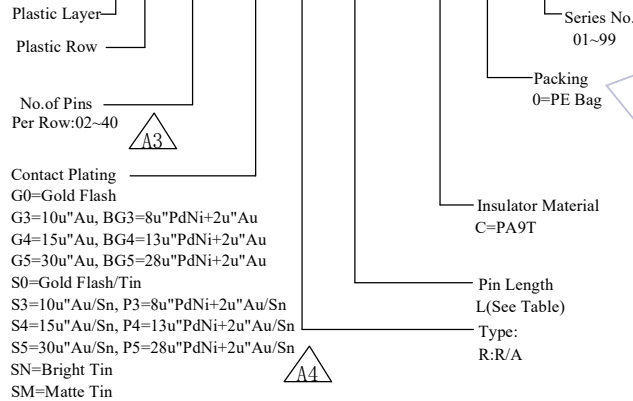

A4	2025/07/31	Standardization Drawing	CP	OPERATION	DRAW	DATE	SCALE	Fit	PART NO. 1215-23XXXXRXXXCOXX $\triangle A1$
A3	2020/06/12	Modify Pin 03~40P	Du Ying	x.X ±0.40	CP	2025/07/31	UNIT	mm	
A2	2019/03/04	Modify	Ding	x.XX ±0.25	CHECK	DATE	SIZE	A4	TITLE: PH2.00 THREE ROW DOUBLE PLASTIC 90° H=1.5 CONCAVE BENDING
A0	2012/04/18	NEW	William Chen	x.XXX ±0.15	TANG	2025/07/31	SHEET	1/2	
REV	DATE	MODIFICATION DESCRIPTION	CHANGE	Angle ± 3°	APPROVE	DATE	SHEET	1/2	Customer NO.
				DIM TOL	Steven Zhao	2025/07/31	PROJ.		



Http: www.wcon.com

WCON-Dongguan Tel: +86 769 85358920 Fax: +86 769 85358915 E-mail: sales@wcon.com	WCON-Kunshan Tel: +86 512 57468408 Fax: +86 512 57468468 E-mail: salesks@wcon.com
---	--

HSF

Packaging Quantity Refers To The Following Table

Table 1

Item	Pin Length Short/Middle/Long	A	C	D	E	B	Mating	
Standard	12.0/16.0/20.0	2.80	4.2	1.5	5.9	2.5	2220T/2221/2228	
	12.5/16.5/20.5					3.0	2227T/2228T/2245	
	13.0/17.0/21.0					3.5	2235/2240N/2243C	
	13.5/17.5/21.5					4.0	2240/2243/2245T/2263/2272	
	21.3/25.2/29.3		14.1	0.95	15.3	2.5	2220T/2221/2228	
	21.8/25.8/29.8					3.0	2227T/2228T/2245	
	22.2/26.2/30.2					3.5	2235/2240N/2243C	
	22.8/26.8/30.8					4.0	2240/2243/2245T/2263/2272	
Standard	11.0/15.0/19.0	2.0	4.2	1.5	5.95	2.5	2220T/2221/2228	
	11.5/15.5/19.5					3.0	2227T/2228T/2245	
	12.0/16.0/20.0					3.5	2235/2240N/2243C	
	12.5/16.5/20.5					4.0	2240/2243/2245T/2263/2272	
	20.3/24.2/28.3		(THR)	14.1	0.95	15.3	2.5	2220T/2221/2228
	20.8/24.8/28.7						3.0	2227T/2228T/2245
	21.3/25.2/29.3						3.5	2235/2240N/2243C
	21.8/25.8/29.8						4.0	2240/2243/2245T/2263/2272
Alternate								

PINS /Row	Q'ty/Bag (11.0 ≤ L ≤ 13.5)	PINS /Row	Q'ty/Bag (11.0 ≤ L ≤ 13.5)	PINS /Row	Q'ty/Bag (20.3 ≤ L ≤ 22.8)	PINS /Row	Q'ty/Bag (20.3 ≤ L ≤ 22.8)
2	1000	22	100	2	800	22	50
3	1000	23	100	3	500	23	50
4	600	24	100	4	400	24	50
5	500	25	100	5	300	25	50
6	400	26	100	6	300	26	50
7	300	27	100	7	200	27	50
8	300	28	100	8	200	28	50
9	300	29	100	9	200	29	50
10	200	30	50	10	100	30	50
11	200	31	50	11	100	31	50
12	200	32	50	12	100	32	50
13	200	33	50	13	100	33	50
14	200	34	50	14	100	34	50
15	100	35	50	15	100	35	50
16	100	36	50	16	100	36	30
17	100	37	50	17	100	37	30
18	100	38	50	18	100	38	30
19	100	39	50	19	50	39	30
20	100	40	50	20	50	40	30
21	100			21	50		

Packing:

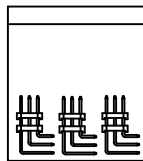

PE Bag

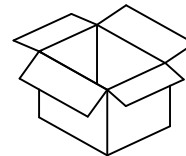

Inner Box

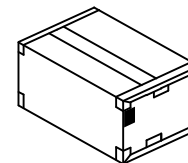

Box

A4	2025/07/31	Standardization Drawing	CP	OPERATION	DRAW	DATE	SCALE	Fit	PART NO.
A3	2020/06/12	Modify Pin 03~40P	Du Ying	x.x ±0.40	CP	2025/07/31	UNIT	mm	1215-23XXXXRXXXCOXX
A2	2019/03/04	Modify	Ding	x.xx ±0.25	CHECK	DATE	SIZE	A4	TITLE:
A0	2012/04/18	NEW	William Chen	x.xxx ±0.15	TANG	2025/07/31	SHEET	2/2	PH2.00 THREE ROW DOUBLE PLASTIC 90° H=1.5 CONCAVE BENDING
REV	DATE	MODIFICATION DESCRIPTION	CHANGE	Angle ± 3°	APPROVE	DATE	PROJ.		Customer NO.
				DIM TOL	Steven Zhao	2025/07/31			

WCON

Http: www.wcon.com

WCON-Dongguan Tel: +86 769 85358920 Fax: +86 769 85358915 E-mail: sales@wcon.com	WCON-Kunshan Tel: +86 512 57468408 Fax: +86 512 57468468 E-mail: salesks@wcon.com
---	--