

HSF

NOTES:

- Rated Current:5.0AMP.(20°C,2*2P-2*15P)
- 3.0AMP.(20°C,2*16P-2*40P) $\triangle A2$
- Contact Resistance:20mΩ Max.
- Withstand Voltage:1000V AC/DC
- Insulation Resistance:1000MΩ Min.
- Operation Temperature: -40°C to +125°C(Gold Plating)
- 40°C to +105°C(Tin Plating) $\triangle A2$
- Contact Material:Copper Alloy
- Contact Plating:Au or Sn Over 30u" Min Ni
- Insulator Material:PA9T+G.F UL94V-0 BK $\triangle A2$

Recommended P.C.B Layout (Top Side)
(PCB BOARD TOLERANCE ± 0.05)
(PCB Thickness:T=1.60m)

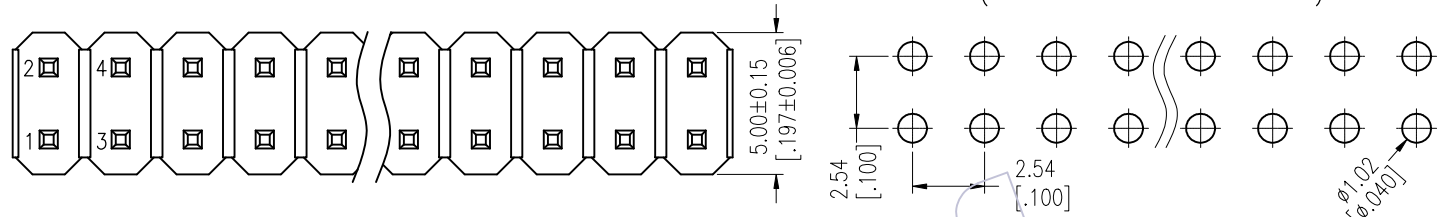

Ordering Information

1115-2 2 XX XX S XXX C 0 XX $\triangle A1$

- Plastic Layer
- Plastic Row
- No. of Pins Per Row:02-40
- Contact Plating:
 - G0=Gold Flash
 - G3=10u"Au, BG3=8u"PdNi+2u"Au
 - G4=15u"Au, BG4=13u"PdNi+2u"Au
 - G5=30u"Au, BG5=28u"PdNi+2u"Au
 - S0=Gold Flash/Tin
 - S3=10u"Au/Sn, P3=8u"PdNi+2u"Au/Sn
 - S4=15u"Au/Sn, P4=13u"PdNi+2u"Au/Sn
 - S5=30u"Au/Sn, P5=28u"PdNi+2u"Au/Sn
 - SN=Bright Tin
 - SM=Matte Tin $\triangle A2$
- Insulator Material C=PA9T
- Pin Length See Table 1
- Type: S:S/T
- Series No. 01-99
- Packing 0=PE Bag T=Tube

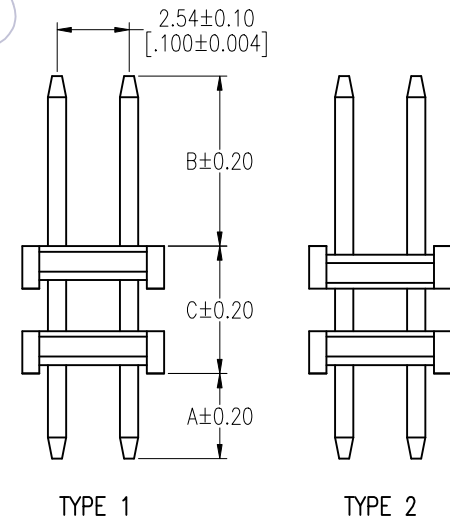
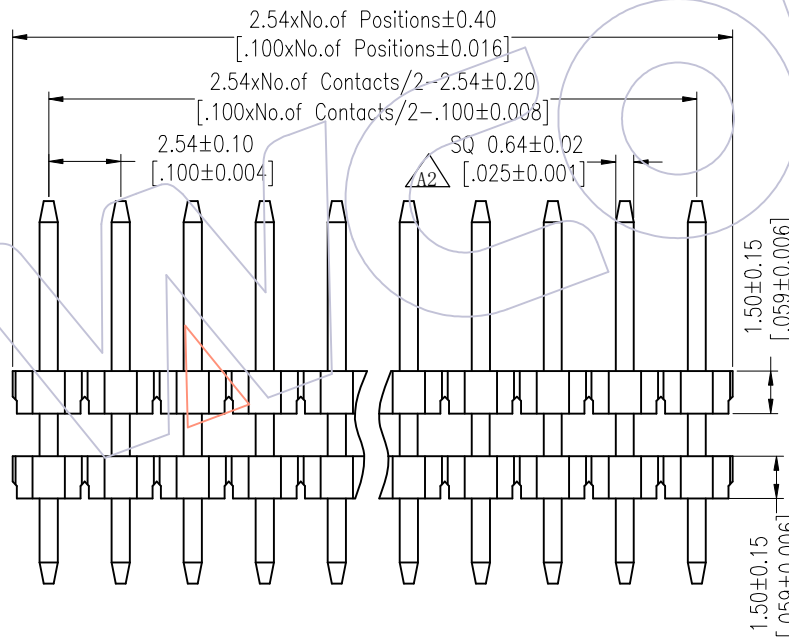

REV	DATE	MODIFICATION DESCRIPTION	CHANGE	OPERATION	DRAW	DATE	SCALE	Fit	PART NO.
A2	2025/07/16	Standardization Drawing	CP	x.X ±0.40	CP	2025/07/16	UNIT	mm	1115-22XXXXXXXC0XX
A1	2018/01/22	Modify P/N	Ruipeng	x.xx ±0.25	CHECK	DATE	SIZE	A4	TITLE:
A0	2012/05/02	NEW	William Chen	x.xxx ±0.15	TANG	2025/07/16	SHEET	1/4	PH2.54 DUAL ROW DOUBLE PLASTIC 180°H=1.5
				Angle ± 3'	APPROVE	DATE	PROJ.		Customer NO.
				DIM TOL	Steven Zhao	2025/07/16			

WCON

Http: www.wcon.com

WCON-Dongguan Tel: +86 769 85358920 Fax: +86 769 85358915 E-mail: sales@wcon.com

WCON-Kunshan Tel: +86 512 57468408 Fax: +86 512 57468468 E-mail: salesks@wcon.com

HSF

Packing:

PE Bag:

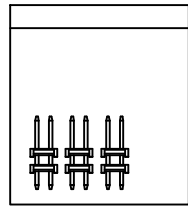

PE Bag

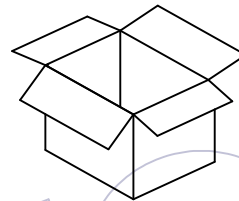
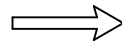

Inner Box

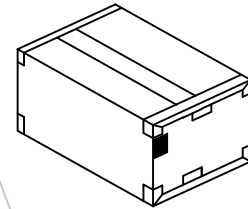
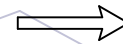

Box

Tube:

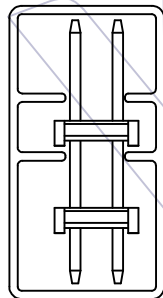

Tube

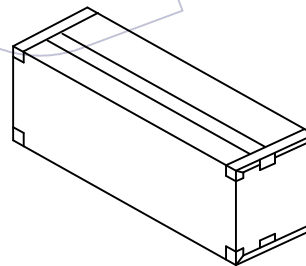

Inner Box

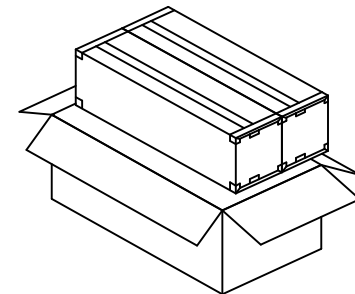
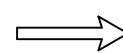

Box

REV	DATE	MODIFICATION DESCRIPTION	CHANGE	OPERATION	DRAW	DATE	SCALE	Fit	PART NO.	 Http: www.wcon.com WCON-Dongguan Tel: +86 769 85358920 Fax: +86 769 85358915 E-mail: sales@wcon.com WCON-Kunshan Tel: +86 512 57468408 Fax: +86 512 57468468 E-mail: salesks@wcon.com
A2	2025/07/16	Standardization Drawing	CP	x.X ±0.40	CP	2025/07/16	UNIT	mm	1115-22XXXXSXXXC0XX	
A1	2018/01/22	Modify P/N	Ruipeng	x.XX ±0.25	CHECK	DATE	SIZE	A4	TITLE: PH2.54 DUAL ROW DOUBLE PLASTIC 180°H=1.5	
A0	2012/05/02	NEW	William Chen	x.XXX ±0.15	TANG	2025/07/16	SHEET	2/4	Customer NO.	
				Angle ± 3'	APPROVE	DATE	PROJ.	⌀		
				DIM TOL	Steven Zhao	2025/07/16				



Table 1

Packaging Quantity Refers To The Following Table

Item	Pin Length	A	C	B	Mating	
Standard	9.5	3.00	3.0	3.5	2135/2150T/2157	
	10.0			4.0	2145/2150	
	11.0			5.0	2168T/2171T	
	11.8			5.84	2171/2185X	
	11.5			3.5	2135/2150T/2157	
	12.0			4.0	2145/2150	
	13.0	5.0	2168T/2171T			
	13.8	5.84	2171/2185X			
	13.3	6.7	3.0	3.5	2135/2150T/2157	
	13.8			4.0	2145/2150	
	14.8			5.0	2168T/2171T	
	15.5	10.0	5.0	5.84	2171/2185X	
	16.5			3.5	2135/2150T/2157	
	17.0			4.0	2145/2150	
	18.0			5.0	2168T/2171T	
	18.8			5.84	2171/2185X	
	8.5			2.0 (THR)	3.0	3.5
	9.0	4.0	2145/2150			
10.0	5.0	2168T/2171T				
10.8	5.84	2171/2185X				
10.5	5.0	3.0	3.5		2135/2150T/2157	
11.0			4.0		2145/2150	
12.0			5.0		2168T/2171T	
12.8	6.7	5.0	5.84		2171/2185X	
12.3			3.5		2135/2150T/2157	
12.8			4.0		2145/2150	
13.8			5.0		2168T/2171T	
14.5			5.84		2171/2185X	
15.5			10.0		5.0	3.5
16.0	4.0	2145/2150				
17.0	5.0	2168T/2171T				
17.8	5.84	2171/2185X				
Alternate						

PINS /Row	Q' ty/Bag (L≤10.0)	PINS /Row	Q' ty/Bag (L≤10.0)
1	1000	21	200
2	1000	22	200
3	1000	23	200
4	1000	24	200
5	1000	25	200
6	500	26	200
7	500	27	200
8	500	28	100
9	500	29	100
10	300	30	100
11	300	31	100
12	300	32	100
13	300	33	100
14	300	34	100
15	200	35	100
16	200	36	100
17	200	37	100
18	200	38	100
19	200	39	100
20	200	40	100

PINS /Row	Q' ty/Bag (10.0<L≤16.0)	PINS /Row	Q' ty/Bag (10.0<L≤16.0)
1	1000	21	100
2	1000	22	100
3	1000	23	100
4	1000	24	100
5	1000	25	100
6	300	26	100
7	500	27	100
8	500	28	100
9	300	29	100
10	300	30	100
11	200	31	100
12	200	32	100
13	200	33	100
14	200	34	100
15	200	35	100
16	200	36	100
17	200	37	100
18	200	38	100
19	200	39	100
20	100	40	100

REV	DATE	MODIFICATION DESCRIPTION	CHANGE	OPERATION	DRAW	DATE	SCALE	Fit	PART NO.	 Http: www.wcon.com WCON-Dongguan Tel: +86 769 85358920 WCON-Kunshan Tel: +86 512 57468408 Fax: +86 769 85358915 Fax: +86 512 57468468 E-mail: sales@wcon.com E-mail: salesks@wcon.com
A2	2025/07/16	Standardization Drawing	CP	x.X ±0.40	CP	2025/07/16	UNIT	mm	1115-22XXXXXXC0XX	
A1	2018/01/22	Modify P/N	Ruipeng	x.XX ±0.25	CHECK	DATE	SIZE	A4	TITLE: PH2.54 DUAL ROW DOUBLE PLASTIC 180°H=1.5	
A0	2012/05/02	NEW	William Chen	x.XXX ±0.15	TANG	DATE	SHEET	3/4	Customer NO.	
				Angle ± 3'	APPROVE	DATE	PROJ.			
				DIM TOL	Steven Zhao	2025/07/16				

HSF

Packaging Quantity Refers To The Following Table

C=3.0/5.0/6.7

C=3.0/5.0/6.7

PINS /Row	Q' ty/Bag (16.0<L≤19.0)	PINS /Row	Q' ty/Bag (16.0<L≤19.0)
1	1000	21	150
2	500	22	150
3	500	23	150
4	300	24	150
5	300	25	100
6	300	26	100
7	300	27	100
8	200	28	100
9	200	29	100
10	200	30	50
11	200	31	50
12	200	32	50
13	200	33	50
14	200	34	50
15	200	35	50
16	200	36	50
17	200	37	50
18	200	38	50
19	200	39	50
20	150	40	50

PINS /Row	Q' ty/Tube	Q' ty/Inner Box	Q' ty/Box
4	54	6,480	12,960
5	46	5,520	11,040
6	37	4,440	8,880
7	31	3,720	7,440
8	27	3,240	6,480
9	24	2,880	5,760
10	22	2,640	5,280
11	20	2,400	4,800
12	18	2,160	4,320
13	17	2,040	4,080
14	16	1,920	3,840
15	15	1,800	3,600
16	14	1,680	3,360
17	13	1,560	3,120
18	12	1,440	2,880
19	11	1,320	2,640
20	11	1,320	2,640
21	10	1,200	2,400
22	10	1,200	2,400

PINS /Row	Q' ty/Tube	Q' ty/Inner Box	Q' ty/Box
23	9	1,080	2,160
24	9	1,080	2,160
25	9	1,080	2,160
26	8	960	1,920
27	8	960	1,920
28	8	960	1,920
29	7	840	1,680
30	7	840	1,680
31	7	840	1,680
32	7	840	1,680
33	6	720	1,440
34	6	720	1,440
35	6	720	1,440
36	6	720	1,440
37	6	720	1,440
38	5	600	1,200
39	5	600	1,200
40	5	600	1,200

REV	DATE	MODIFICATION DESCRIPTION	CHANGE	OPERATION	DRAW	DATE	SCALE	Fit	PART NO.	 Http: www.wcon.com WCON-Dongguan Tel: +86 769 85358920 Fax: +86 769 85358915 E-mail: sales@wcon.com WCON-Kunshan Tel: +86 512 57468408 Fax: +86 512 57468468 E-mail: salesks@wcon.com
A2	2025/07/16	Standardization Drawing	CP	x.X ±0.40	CP	2025/07/16	UNIT	mm	1115-22XXXXXXC0XX	
A1	2018/01/22	Modify P/N	Ruipeng	x.XX ±0.25	CHECK	DATE	SIZE	A4	TITLE: PH2.54 DUAL ROW DOUBLE PLASTIC 180°H=1.5	
A0	2012/05/02	NEW	William Chen	x.XXX ±0.15	TANG	DATE	SHEET	4/4	Customer NO.	
				Angle ± 3'	APPROVE	DATE	PROJ.			
				DIM TOL	Steven Zhao	2025/07/16				